

Fuzzy Logic Controlled Shunt Active Filter in IEEE Nine Bus System with Improved Dynamic Time Response

¹S.DHANDAYUTHAPANI ²Dr.C.SHARMEELA

¹Research scholar / EEE, SCSVMV University, Kancheepuram dhand_au@yahoo.com

²Assistant Professor / EEE, College of Engineering, Guindy, Anna University

Abstract: This paper aims on improving the dynamic time response of a wind energy conversion system (WECS) connected to IEEE Nine bus system using Permanent magnet synchronous generator (PMSG) in closed loop controlled Active Power Filter with FLC. Shunt active filter (SAF) is the family of FACTS device which is implemented with voltage source inverter (VSI), to generate switching pulses using Fuzzy logic controller. Open loop controlled nine bus system with change in load is simulated in MATLAB. The simulation results with PI and FLC based SAF are compared and the corresponding time-domain parameters are presented. The results indicate that Fuzzy Logic controlled system has better response than PI controlled system.

Key words: Shunt Active filter, IEEE nine bus system, Fuzzy logic controller, PI controller, Voltage Source Inverter, Reactive power, Time domain parameters, Matlab.

I. Introduction

Recently a lot of work has been done in power quality and custom power problems in the distribution system arising from non-linear loads [1]. These non-linear loads are introducing harmonic distortion and reactive power problems. The harmonics in the system induce several undesirable issues, such as increased heating losses in transformers, low power factor, torque pulsation in motors, poor utilization of distribution plant and also affects other loads connected at the same Point of Common Coupling (PCC). Conventionally, passive LC filters and fixed compensating devices with some degree of variation like thyristor switched reactors, thyristor switched capacitors were employed to improve the power factor of ac loads. The demerits of such devices are of fixed compensation, large size, ageing and resonance. Nowadays equipments using power semiconductor devices, generally known as active power filters (APF's) [2], Power Line Conditioners in active mode are used for the power quality issues due to their dynamic and adjustable solutions. Power Filters were developed to reduce the harmonics and reactive power simultaneously. The APF circuit can be connected in series or parallel and

combinations of both as well as hybrid configurations [3]. The shunt active filter is prominent than the series active filter, because most industrial applications require the current harmonic compensation [4]. Reactive power compensation using SAF [5] is controlled by adaptive FLC. The PI controller needs a linear mathematical model of the system, which is difficult to obtain under parameter variations and non-linear load disturbances. FLCs were proposed in various power electronic applications and also in active power filters [6]. The PI controlled three phase SAF with non-sinusoidal main voltage problem is resolved by phase locked loop [7]. Fuzzy-adaptive hysteresis band technique is used to derive the switching signals for the voltage source inverter [8].

The above literature does not deal with FLC-SAF applied to IEEE nine bus system. The advantage of FLCs over the conventional controllers is that it does not need an accurate mathematical model. It can handle nonlinearity and is more robust than the conventional PI or PID controllers. This paper presents a shunt APF that uses a PI and fuzzy logic controller.

Voltage collapse is a manifestation of voltage instability in the system. Voltage stability refer to the ability of power system to maintain steady voltages at all buses in the system after being subjected to a disturbance from a given initial operating point. The system state enters the voltage instability region when a disturbance or an increase in load demand or alteration in system state results in an uncontrollable and continuous drop in system voltage. A system is said to be in voltage stable state if at a given operating condition, for every bus in the system, the bus voltage magnitude increases as the reactive power injection at the same bus is increased. A system is voltage unstable if for at least one bus in the system, the bus voltage magnitude decreases as the reactive power injection at the same bus is increased.

The active filter is implemented with VSI (Voltage source inverter) and switching patterns are generated from the proposed fuzzy logic controller. In this paper an additional load disturbance is created in

bus 7. Voltage stability [9] is improved in the bus 7. Final results shows steady state and settling time error is lower by using fuzzy.

The shunt APF system is validated through extensive simulation of several case studies. In Section II, the principle of shunt APF system architecture is presented. Section III describes the block diagram of Shunt active filter with PI and Fuzzy controllers. Section IV describes the proposed single line diagram of IEEE nine bus system with wind generator. In section V the performance of simulation results to verify the validity and effectiveness of the shunt active filter equipped with the fuzzy logic control is presented. Section VI describes the experimental results of FLC based SAF. Finally, Section VII is a discussion of the conclusions reached in this work.

II. Principle of Shunt Active Power Filter

The principle of the Shunt Active Filter is to produce harmonic currents equal in magnitude but opposite in-phase to those harmonics that are present in the grid. Fig. 1 illustrates the schematic representation of Active Filter. SAPF is a closed loop structure and which used in the load side of the system, because non-linear load is generate harmonics in the current waveform.

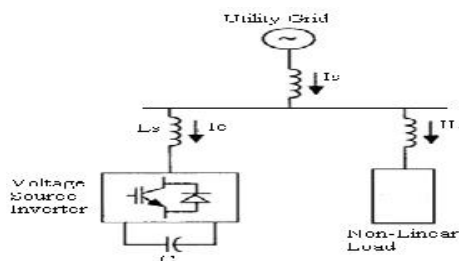

Fig. 1. Schematic Representation of Active Filter

$$I(\text{comp}) = I(\text{load}) - I(\text{source}) \quad (1)$$

The shunt active filters are used to eliminate the unwanted harmonics and compensate fundamental reactive power consumed by nonlinear loads by injecting the compensation currents into the AC lines. Here, the shunt active filter operates as a current source so that it injects harmonic current into the AC system with the same amplitude as that of the load but with an opposite phase. This principle is applicable to any type of load. The AF has VSI and a series inductor.

Fig.1.1 represents the schematic diagram of Shunt

active filter. The shunt active filter [10] is comprised by the controller block, the inverter block (IGBT module), the DC bus (with a single capacitor), and the coupling to the power system block (with an inductance for each phase and neutral wire).

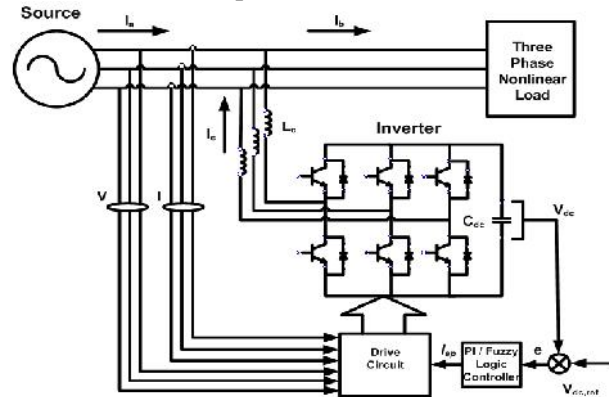

Fig. 1.1. Schematic Diagram of Shunt Active Filter

The DC side capacitor serves two main purposes: (i) it maintains a DC voltage with small ripple in steady state, and (ii) serves as an energy storage element to supply real power difference between load and source during the transient period. In the steady state, the real power supplied by the source should be equal to the real power demand of the load plus a small power to compensate the losses in the active filter. Thus, the DC capacitor voltage can be maintained at a reference value.

The inverter is used to charge and to provide the required compensation current. The capacitor (C) is used to store energy and the inductance (Ls) is used to smooth and decrease the ripple of the harmonic current injected by the active power filter. The AC supply provides the required active power and the capacitor of active power filter provides the reactive power for the load.

A three phase MOSFET based bridge with an energy storage capacitor on the DC side is connected in parallel with the load and acts as a voltage fed inverter. The three phase inverter is built by six MOSFETs that are chosen according to their rating. Anti parallel diodes are connected across these power switches for protection and provides power conversion in reverse direction in order to recharge the DC capacitor whenever its level goes lower than a reference value. The large size capacitor is connected to the inverter so that a constant level of voltage can be maintained over each switching cycle.

An inductor, when connected in series circuit with the inverter circuit will provide better isolation for high

frequency components. Control of the injected current wave shape is limited by the switching frequency of the inverter and the available driving voltage across the interfacing inductance.

III. Block diagram

A. Shunt Active Filter with PI controller :

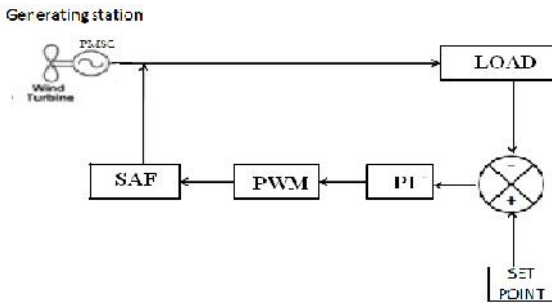

Fig.2. Shunt Active Filter with PI controller

Fig.2. shows the block diagram of the implemented PI control scheme of a shunt active filter. The block diagram consists of:

1. Reference current calculation block.
2. PI controller.
3. PWM controller.
4. Shunt Active Filter.
5. Dc voltage regulator.

The shunt active power filter mainly consists of DC link capacitor, PI controller, PWM controller.

1.DC Link Capacitor : The DC link capacitor mainly serves two purposes- (a) Constant DC voltage is maintained. (b) It serves as an energy storage element to supply real power difference between load and source during transients. In this scheme the role of the DC link capacitor is to absorb/supply real power demand of the load during transient.

2. PI Controller : The discrete PI controller that takes the reference and actual voltage and gives the maximum value of the reference current depending on the error is shown in Fig.2.1

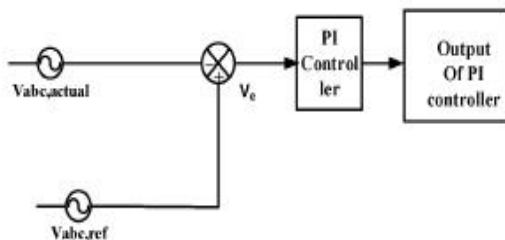

Fig. 2.1 Block diagram of PI controller

3.PWM controller: To control the shunt active filter a PWM logic controller is developed. The difference

between the injected current and the reference current determine the modulation wave of the reference voltage. This voltage is compared and generate switching pulses.

B. Shunt Active Filter with Fuzzy logic controller:

The Fuzzy Logic tool is a mathematical tool for dealing with uncertainty. It is important to observe that there is an intimate connection between Fuzziness and Complexity.

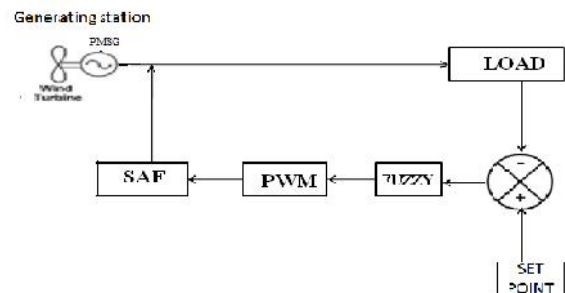

Fig. 3. Shunt Active Filter with Fuzzy Logic Controller

The advantages of fuzzy controllers over conventional controllers like PI controllers are that they do not need accurate mathematical model, they can work with imprecise inputs, can handle non-linearity, load disturbances etc.

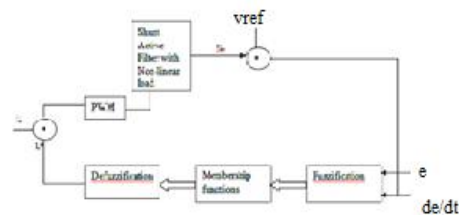

Fig.3.1 Block diagram of Fuzzy Logic Controller

Fig.3 shows the block diagram of the implemented fuzzy logic control scheme of a shunt active power filter. Fig.3.1 shows the diagram of the control algorithm. In order to implement the control algorithm of a shunt active power filter in closed loop, the DC side capacitor voltage is sensed and then compared with a reference value. The obtained error $e = V_{dc,ref} - V_{dc,act}$ and the change of error signal $Ce(n) = e(n) - e(n-1)$ at the n^{th} sampling instant as inputs for the fuzzy processing. The output of the fuzzy

controller after a limit is considered as the amplitude of the reference current I_{max} takes care of the active power demand of load and the losses in the system.

In the fuzzy logic control algorithm for APF [13] two inputs are required. The inputs are error 'e' and change in error de/dt . The two inputs to FLC are bus voltage (e) and change in bus voltage de/dt are given. The two inputs were related by member functions. Basically forty nine rules are there. Based on the operation it will be used. Twenty five rules are implemented in this work. The membership functions [14] are expressed in negative large (NL), negative small(NS), zero(Z), positive small(PS),and positive big(PB). Actual voltage is compared with the reference voltage, based on that error will be produced. The switching signal for the PWM converter are obtained from comparing the actual source currents with the reference current. The output pulses are applied to the switching devices of the PWM converter. Actual current is compared with the reference current, and error is compensated by fuzzy controller. Fuzzy sets support a flexible sense of membership functions.

A Proportional Resonant (PR) current controller[16] for selective harmonic compensation in a hybrid active power filter is implemented in synchronous reference frame. Proportional Resonant controllers has compensate for both positive as well as negative sequence components simultaneously[17]. Frequency-adaptive fractional-order repetitive control[18] of shunt active power filters eliminate harmonic distortions under grid frequency variations. vector resonant controller[19] with SAF act as multiband rejection filter and block the selected harmonic components from the load side flowing into the source side. Synchronous frame[20] is used to get the reference signals for APF.

IV. IEEE Nine bus system with wind generator :

The circuit of Active filter is shown in Fig. 4.2. Large AC capacitor is not available. Therefore a large DC capacitor is selected and it is added on DC side. The capacitor on the DC side and the inductor on the AC side are the elements of the filter. The DC source on the input side makes it an active filter. The filter is tuned to the frequency requires by the load. The single line diagram of nine bus system is shown in Fig.4.1 This has Three-generator buses and six load buses. The line data and load data is given in Table 1.The generators buses are bus-1, bus-2 (wind generator) and bus-3(wind generator) respectively. The buses 5, 6 and 8 represent load buses.

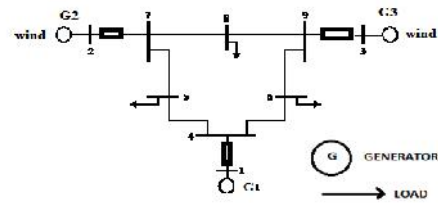

Fig. 4.1 IEEE Nine bus system-single line diagram

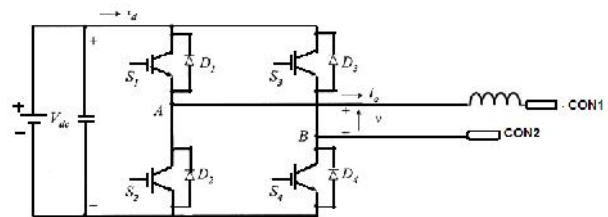

Fig. 4.2 Circuit of Shunt Active Filter

V. Simulation Results

The simulation is done using MATLAB simulink and the results are discussed in this section. The open loop simulink model of nine bus system with additional load is shown in Fig.5. The additional load is connected to bus 7. The voltage at bus 7 decreases as shown in Fig.5.1. The RMS voltage is shown in Figure 5.2. The decrease in bus voltage is due to the increase in the impedance drop. The voltage decreases from 2300 to 1800 V. The real and reactive powers at bus no 7 are shown in Fig.5.3 and Fig.5.4 respectively.

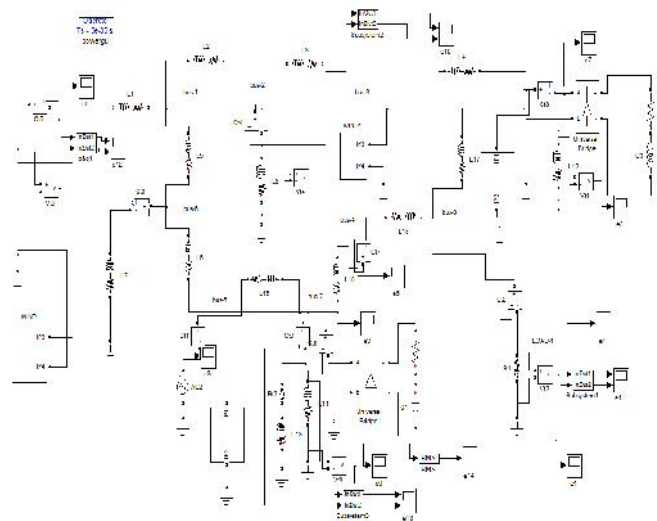

Fig.5 Simulink model of Nine bus system with wind generation for open loop system (with additional load)

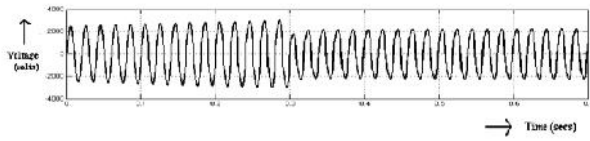

Fig.5.1 voltage at bus no 7

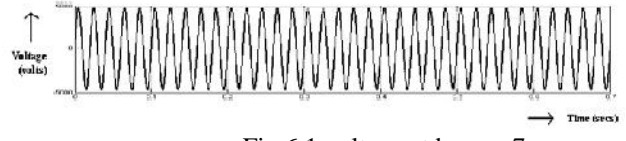

Fig.6.1 voltage at bus no 7

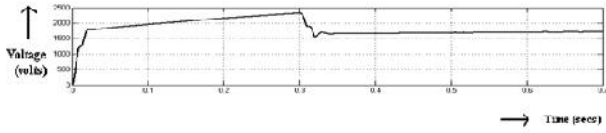

Fig.5.2 RMS voltage at bus no 7

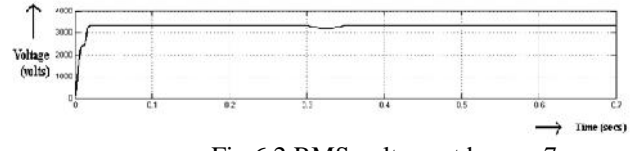

Fig.6.2 RMS voltage at bus no 7

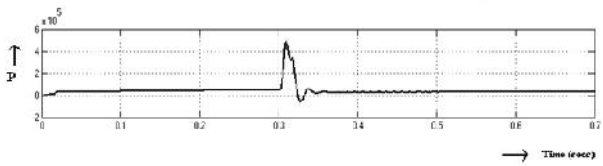

Fig.5.3 Real power at bus no 7

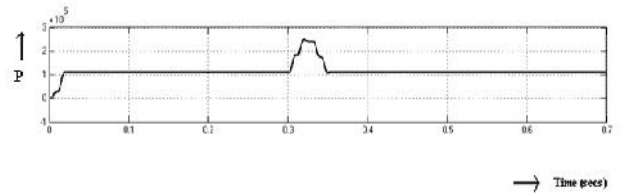

Fig.6.3 Real power at bus no 7

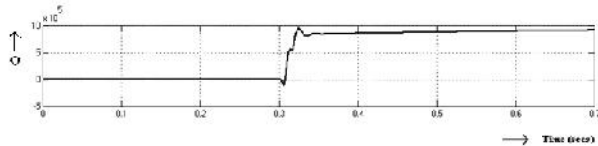

Fig.5.4 Reactive power at bus no 7

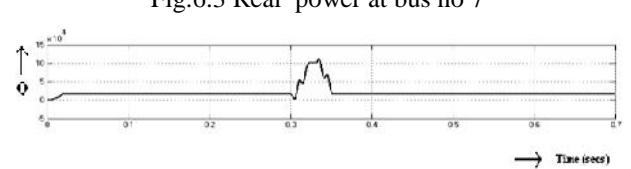

Fig.6.4 Reactive power at bus no 7

A.Simulation results with PI controller :

The simulink model of closed loop system with PI controller is shown in Fig.6. The bus voltage is shown in Fig.6.1. The RMS voltage representation at bus no 7 is shown in Fig.6.2. The real and reactive powers at bus no 7 are shown in Fig. 6.3 and 6.4 respectively. The real power is 0.1085MW and reactive power is 0.0170MVAR.

B.Simulation results with Fuzzy Logic Controller :

The rule table for the designed fuzzy controller is given in the Table I. For the two inputs, five membership functions and derived 25 rules. Nine bus system in closed loop are simulated and the results with FLC are presented. The closed loop system with FLC is shown in Fig. 8. The bus voltage is shown in Fig.8.1. The RMS representation of voltage at bus no 7 is shown in Fig.8.2. The real and reactive powers at bus no 7 are shown in Fig 8.3 and 8.4. Real power is 0.10 MW and reactive power is 0.016 MVAR. It can be seen that fluctuation in the voltage is negligible and the response is faster with Fuzzy logic controller [15].

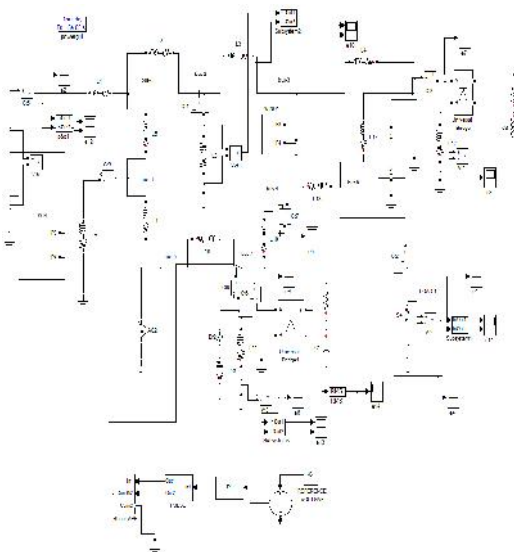

Fig. 6.Simulink model of closed system with PI controller

Table I.

Error (e)	Fuzzy Rule				
	Change of error (de)				
	NL	NS	Z	PS	PB
NL	Z	PS	NS	NL	PB
NS	NS	Z	PB	NS	PS
Z	NL	PS	Z	NS	PB
PS	NS	NL	PB	Z	PS
PB	PB	NS	PS	NL	Z

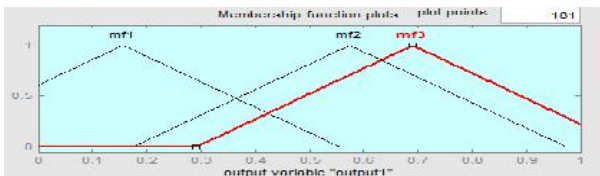
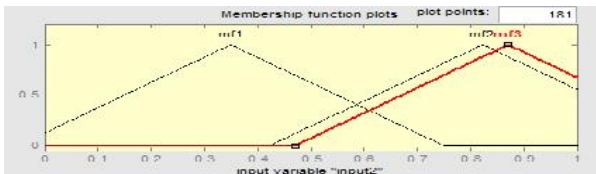
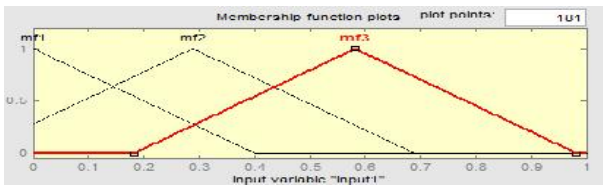

Fig. 7 Membership function for input error, change of error and output variable

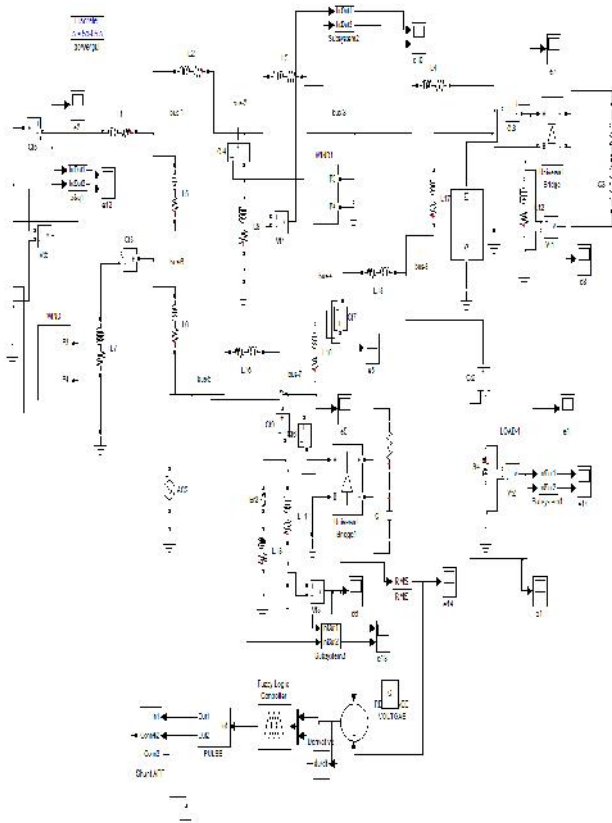

Fig. 8 Simulink Model of the Closed Loop System with FLC

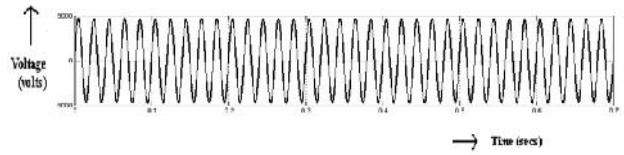

Fig.8.1 Voltage at bus no 7

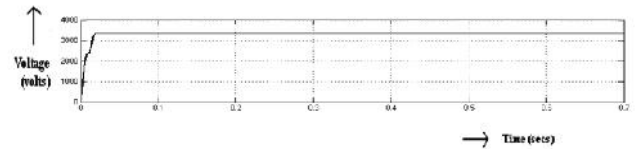

Fig.8.2 RMS Voltage at busno 7

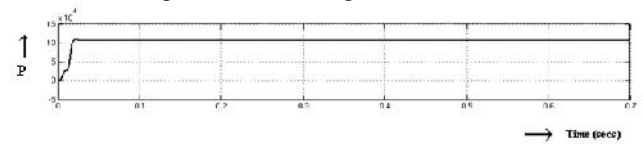

Fig.8.3 Real Power at bus no 7

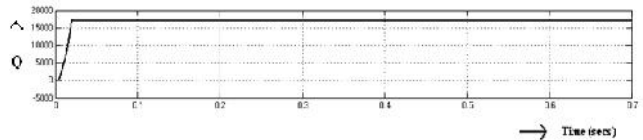

Fig.8.4 Reactive Power at bus no 7

The summary of time domain parameters is given in Table II. From that results the steady state error is reduced from 5V to 0.05V and settling time is reduced from 0.35 seconds to 0.04 seconds. Therefore FLC based active filter may be a viable alternative to the existing.

Table II. Summary of Time Domain Parameters

Controllers	Rise time (sec)	Peak time (sec)	Settling time (sec)	Steady state error(V)
PI controller	0.02	0.03	0.35	5
FLC	0.01	0.03	0.04	0.05V

VI. Experimental Results:

Hardware snap shot for FLCSAF is appeared in Fig 9.1. DC input Voltage across FLCSAF is shown in Fig 9.2. Switching pulse for inverter M1 and M3 is appeared in Fig 9.3. Switching pulse for inverter M2 and M4 is appeared in Fig 9.4. Output voltage of FLCSAF is appeared in Fig 9.5.

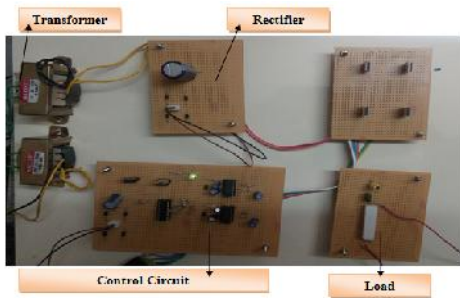

Fig 9.1 Hardware snap shot with FLCSAF

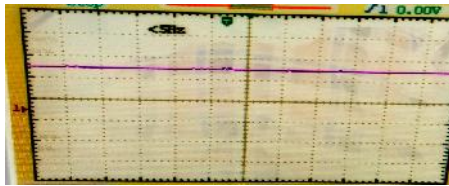

Fig 9.2 DC input voltage

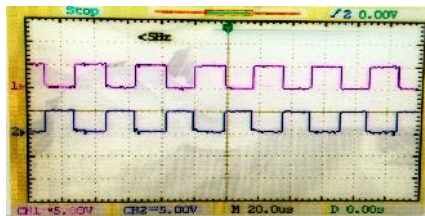

Fig 9.3 Switching pulse for M1& M3 of inverter

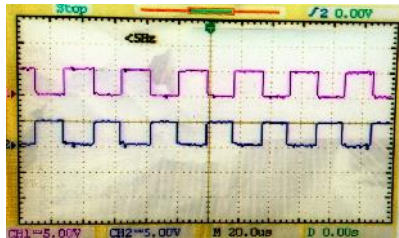

Fig 9.4 Switching pulse for M2 & M4 of inverter

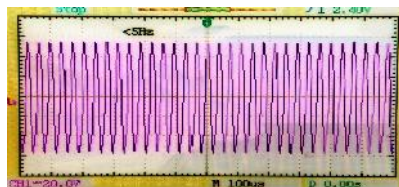

Fig 9.5 Output voltage of FLCSAF

VII. Conclusion:

IEEE nine bus closed loop system are simulated and the results with PI and FLC are presented. The hardware for FLCSAF is fabricated and tested. The experimental results are presented. The advantages of proposed system are reduction in losses, line drop, steady state error and settling time. The disadvantage is

that it requires large inductor and capacitor. The present work deals with the investigation on nine bus system. The improvement in power quality of fourteen bus system will be explored in future.

APPENDIX – I

System Parameters

Sl.no	Parameters	Values
1	Frequency	50 Hz
2.	Wind generator	9 MW
2	Source voltage	6.3KV
3	Line impedance	3 10mH
4	PI controller	Kp-2,Ki-0.5
5	Load impedance	1 ,70mH
6	Inductance of active filter	100mH
7	Output capacitance	100 μ F

APPENDIX – II

Line and Load data

Bus	voltage	Load impedance	
Bus 1	6350	-	-
Bus 2	6350	-	-
Bus 3	6350	-	-
Bus 5	-	5	60mH
Bus 6	-	100	50mH
Bus 8	-	100	50mH

Line	Resistance	Inductance
1-4	3	10mH
4-5	5	15mH
5-7	3	10mH
2-7	2	8mH
7-8	3	10mH
8-9	9	50mH
3-9	5	15mH
6-9	3	10mH
1-6	5	15mH

REFERENCES

- [1] N. Mendalek, K. Al Haddad, L.A-Dessaint and F. Fnaiech " Nonlinear Control technique to enhance dynamic performance of a shunt active power filter " - IEEE Proceedings Electrical Power Applications - vol.150 no 4, July 2003.

- [2] B. Singh, K. Ai-Haddad, and A. chandra, "A review of active filters for power quality improvement" IEEE Transaction on Industrial electronics, Vol. 46, Issue no. 5, Oct-1999, pp 960-971.
- [3] S. P. Litrán, P. Salmerón, R.S. Herrera, "Hybrid active power filter: design criteria," International Conference on Renewable Energies and Power Quality, 2011.
- [4] C. Lascu, L. Asiminoaei, I. Boldea & F. Blaabjerg, "High performance current controller for selective harmonic compensation in active power filters," IEEE Trans. on Power Electronics, vol. 22(5), pp. 1826- 1835, 2007.
- [5] S. Saidi, S. Chebbi, H. Jouini, "Harmonic and reactive power compensations by shunt active filter controlled by adaptive fuzzy logic," International Review of Electrical Engineering, vol. 4(4), 1487-1492, 2011.
- [6] S. K. Jain, P. Agrawal, H. O. Gupta, "Fuzzy logic controlled shunt active power filter for power quality improvement" IEE Proceedings Electric Power Applications, Vol. 149, No. 5, pp. 317–328, 2002.
- [7] C. Abdelmadjid, G. Jean Paul, K. Fateh, C. Gerard, "PI controlled three-phase shunt active power filter for power quality improvement. Electric Power Components and Systems," pp. 1331–1344, 2007.
- [8] P. Rathika, D. Devaraj "Fuzzy Logic-Based approach for adaptive hysteresis band and DC voltage control in shunt active filter," International Journal of Computer and Electrical Engineering, Vol. 2(3), 2010, pp. 1793-8163.
- [9] S. Sindhuja, K. Madumathi, M. Muruganandham "Enhancing the stability of a single bus system using shunt active filter," International IEEE conference on Electrical, Electronics, Signals, Communication and Optimization (EESCO), 2015, Pages 1 – 4.
- [10] Siddharthsingh K. Chauhan; Mihir C. Shah; Ram Ratan Tiwari; P. N. Tekwani "Analysis, design and digital implementation of a shunt active power filter with different schemes of reference current generation," IET Journals on Power Electronics, Vol. 7(3), 2014, pp. 627-639.
- [11] Anil M. Gore; Dagadu .More "Performance investigation of Shunt Active Power Filter with PI and fuzzy controllers," IEEE International Conference on Control Applications (CCA), 2013, pp 1-9.
- [12] Karuppanan P and KamalaKanta Mahapatra "PLL with PI, PID and Fuzzy Logic Controllers based Shunt Active Power Line Conditioners" IEEE PEDES- International Conference on Power Electronics, Drives and Energy Systems- Dec 21 to 23, 2010 at IIT-Delhi.
- [13] S. K. Jain; P. Agrawal; H. O. Gupta " Fuzzy logic controlled shunt active power filter for power quality improvement , " IEE Proceedings on Electric Power Applications, Vol. 149, pp 317-328, 2002.
- [14] Kishore Kumar Pedapenki; S. P. Gupta; Mukesh Kumar Pathak " Fuzzy membership functions based active filter for power quality improvement ," International Conference on Control, Instrumentation, Communication and Computational Technologies (ICCICCT), 2015, Pages. 231-235.
- [15] Pedapenki, K. K., Gupta, S. P., and Pathak, M. K., "Comparison of PI & Fuzzy Logic Controller for Shunt Active Power Filter", 8th IEEE International Conference on Industrial and Information Systems (ICIIS), pp. 42-47, 2013.
- [16] L. Herman, I. Papic, and B. Blazic, "A proportional-resonant current controller for selective harmonic compensation in a hybrid active power filter," IEEE Transactions on Power Delivery, vol. 29, no. 5, pp. 2055–2065, 2014.
- [17] Teodorescu, F. Blaabjerg, M. Liserre, P. C. Loh, "Proportional-resonant controllers and filters for grid-connected voltage-source converters", *Proc. Inst. Elect. Eng. Elect. Power Appl.*, vol. 153, no. 5, Sep. 2006.
- [18] Z. X. Zou, K. Zhou, Z. Wang, and M. Cheng, "Frequency-adaptive fractional-order repetitive control of shunt active power filters," IEEE Transactions on Industrial Electronics, vol. 62, no. 3, pp. 1659–1668, 2015.
- [19] H. Yi, F. Zhuo, Y. Zhang et al., "A source-current-detected shunt active power filter control scheme based on vector resonant controller," IEEE Transactions on Industry Applications, vol. 50, no. 3, pp. 1953–1965, 2014.
- [20] Y. Wang, H. Zheng, R. Wang et al., "A novel control scheme based on the synchronous frame for APF," Journal of Power Electronics, vol. 17, 2017.